

## SPECIFICATIONS

MODEL	FS-1575	FS-2575	FS-5075
OFFICIAL NAME OF EQUIPMENT	SSB RADIOTELEPHONE		

### GENERAL CHARACTERISTICS

Rules and Regulations	ITU-R M.1082-1, ITU-R M.1173, ITU-R M.476-5, ITU-R M.490, ITU-R M.491-1, ITU-R M.492-6, ITU-R M.493-13, ITU-R M.541-9, ITU-R M.625-3, ITU-R M.821-1, IMO Res. A.694(17), IMO Res. A.806(19), IMO Res. MSC36 (63), IMO Res. MSC 68 (68), MSC/Circ. 862, IEC 61162-1 Ed. 4, IEC60945 Ed. 4, ETS 300 067 ed. 1, EN 300 338-1 V1.3.1, EN 300 338-2 V1.3.1, EN 301 033 V1.3.1, EN 300 373-1 V1.3.1		
Frequency Range	TX:	1605.0kHz to 27500.0kHz	
	RX:	100kHz to 29999.99kHz	
Number of Channels	256 user-specified channels plus ITU, SSB/TELEX channels		
Communication Mode	Simplex/Semi-duplex		Simplex/Semi-duplex/Duplex (option)
Class of Emission	J3E, H3E, A1A, J2B		

### TRANSCEIVER

RF Output Power	150 W pep	250 W pep	500 W pep (HF) / 400 W pep (MF)
Antenna	10-18 m whip or wire		
Tuning Speed	within 15 sec		
Receiver Sensitivity	less than +7 dBμV (4.0-29.99999 MHz, J3E) / less than +13 dBμV (1.6-4 MHz, J3E)		

### DSC

Receiving Frequency	General	All DSC frequencies in MF/HF	
	Distress and safety	DSC distress/safety frequencies: 2187.5 kHz, 4207.5 kHz, 6312.0 kHz, 8414.5 kHz, 12577.0 kHz, 16804.5 kHz	
Message Storage	TX:	50 distress messages, plus 50 non-distress messages	
	RX:	50 messages, telephone no., frequencies, etc.	

POWER SUPPLY	24 VDC, 100/110/120/200/220/240 VAC with optional AC/DC Power Supply PR-850A (FS-2575/5075) / PR-300 (FS-1575)		
	20 A (TX), 5.0 A (RX)	40 A (TX), 5.0 A (RX)	60 A (TX), 5.0 A (RX)

### EQUIPMENT LIST

Standard	Option
1 Transceiver Unit FS-1575T (FS-1575), FS-2575T (FS-2575), FS-5075T (FS-5075)	1 Printer PP-510
2 Control Unit FS-2575C	1 Printer Interface IF-8500
3 Handset HS-2003	1 External Speaker SEM-21Q
4 Antenna Coupler AT-5075 (FS-2575/5075) AT-1575 (FS-1575)	1 Control Unit FS-2575C
	1 NBDP Terminal Unit IB-585
	1 BK Interface BK-300
	1 Whip Antenna
	1 AC/DC Power Supply PR-850A (FS-2575/5075) PR-300 (FS-1575)
	1 Full Duplex Kit (for FS-5075) OP05-125
	1 Matching Box ARD-1
	1 Preamp FAX-5
	1 WR2 kit OP05-123

### INTERCONNECTION DIAGRAM

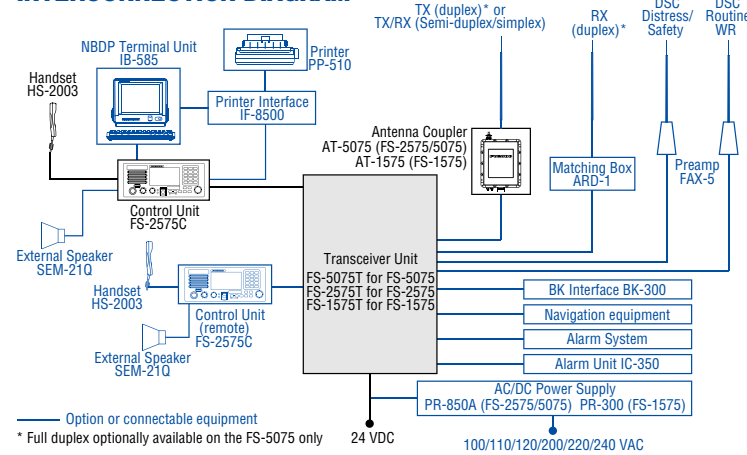

### CONTROL UNIT

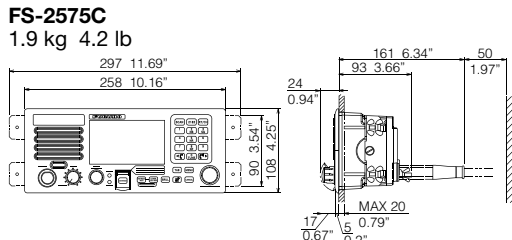

### ANTENNA COUPLER

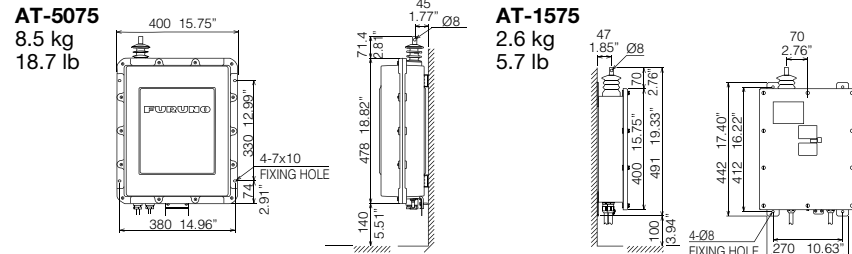

### TRANSCEIVER UNIT

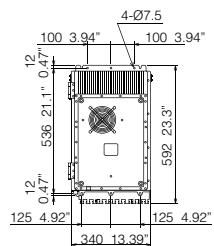
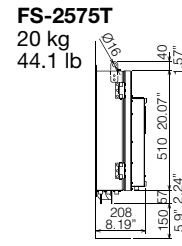
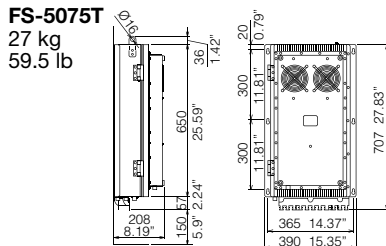

### HANDSET

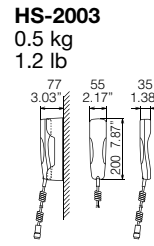

All brand and product names are registered trademarks, trademarks or service marks of their respective holders.  
SPECIFICATIONS SUBJECT TO CHANGE WITHOUT NOTICE

# MF/HF

MF/HF Radiotelephone



## Reliable MF/HF Radiotelephone for general and distress communications with integrated DSC/DSC Watch Receiver



Models: FS-1575 (150 W)  
FS-2575 (250 W)  
FS-5075 (500 W)

- ▶ MF/HF radiotelephone with DSC facility
- ▶ Fully meets GMDSS carriage requirements for SOLAS ships operating in A3 and A4 sea areas
- ▶ Meets the new ITU recommendation on digital selective calling system for use in the Maritime Mobile Service, ITU-R M.493-13
- ▶ High-contrast 4.3" bright color LCD (480x272 pixels)
- ▶ Capable of distress, safety and routine communication
- ▶ Instant selection of 256 user-specified channels with a rotary knob or direct keypad input
- ▶ Quick access to DSC message composition by dedicated keys on the control unit
- ▶ Full-duplex kit available (optional supply for the FS-5075 only)
- ▶ Quick access to dedicated functions in the menu operation using numeric keypad

# Control Panel

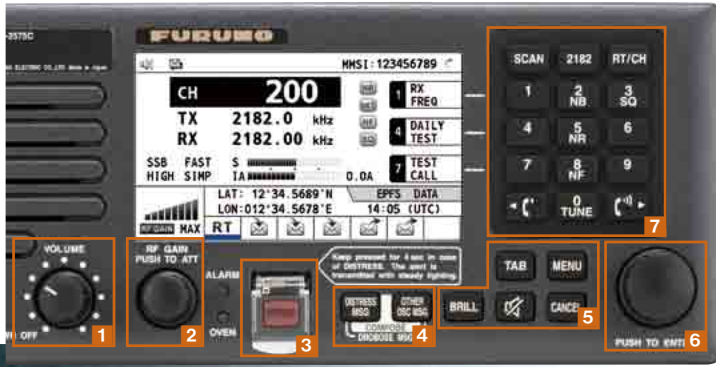

## Simplified menu operation

Numbers are assigned for each of the menu items, and the operator can access each of the menu items either by turning and pressing the PUSH TO ENTER knob to select menu items or simply pressing number on the numeric keypad.

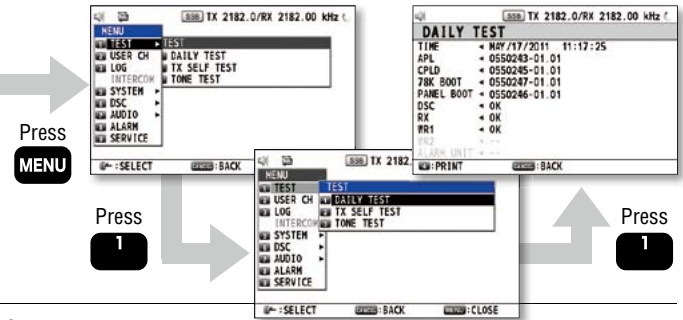

<b>1</b> Volume/Power knob :	Sound volume control/Switching of Power ON/OFF
<b>2</b> RF GAIN knob :	Adjustment of reception gain
PUSH TO ATT :	Press to activate/deactivate RF attenuator
<b>3</b> <b>DISTRESS</b> :	Long-press to transmit a DSC distress alert
<b>4</b> <b>DISTRESS MSG</b> :	Composition of DSC message for distress alert
<b>OTHER DSC MSG</b> :	Composition of DSC message except for distress alert and DROBOSE (DSC relay on behalf of someone else*)
Press <b>DISTRESS MSG</b> + <b>OTHER DSC MSG</b> :	Composition of DSC message for DROBOSE
<b>5</b> <b>BRILL</b> :	Activation of the brilliance control dialog box
<b>TAB</b> :	Activation of tab segment control on the screen
<b>MENU</b> :	Opening/closing of the menu dialog box
<b>CANCEL</b> :	Deactivates alarm/deletion of error and pop-up messages/halting of DSC message composition/exiting from the message composition dialog box/distress cancellation/returning to a previous menu level
<b>Speaker icon</b> :	Switching the speaker ON/OFF
<b>6</b> <b>PUSH TO ENTER</b> knob :	Shifts the selector and pointer/adjusts the degree of parameter, i.e., brilliance and switch over the display mode Press to confirm the entered values
<b>7</b> <b>SCAN</b> :	Switches to the DSC SCAN mode/if pressed during the DSC SCAN mode, routine scan will be halted
<b>2182</b> :	Sets to 2182 kHz SSB
<b>RT/CH</b> :	Switches to radiotelephone mode, and if pressed in radiotelephone mode, channel setting box will be summoned
<b>1</b> :	Used to enter the following number and symbols (. @ - _ / : 1) as well as quick access to short cut function
<b>2 NB</b> :	Used to enter A, B, C and 2, and to switch noise blanker setting ON/OFF
<b>3 SQ</b> :	Used to enter D, E, F and 3, and to switch squelch setting ON/OFF
<b>4</b> :	Used to enter G, H, I and 4 as well as quick access to short cut function
<b>5 NR</b> :	Used to enter J, K, L and 5, and to switch noise reduction setting ON/OFF
<b>6</b> :	Used to enter M, N, O and 6
<b>7</b> :	Used to enter P, Q, R, S and 7 as well as quick access to short cut function
<b>8 NF</b> :	Used to enter T, U, V and 8, and to switch notch filter ON/OFF
<b>9</b> :	Used to enter W, X, Y, Z and 9
<b>Left arrow</b> :	Used to reduce the receiver volume of the handset/to shift the pointer in channel/frequency selection dialog box
<b>0 TUNE</b> :	Used to enter the number "0", space and the following symbols (! " # \$ % & ' ( ) * + , - . / : ; < = > ? @ [ \ ] ^ - { } ~)/ to tune impedance between an antenna and a transceiver
<b>Right arrow</b> :	Used to raise the receiver volume of the handset/to shift the pointer in channel/frequency selection dialog box

\* composition and relay of the occurrence of a distress event obtained by non-DSC means



### Radiotelephone display

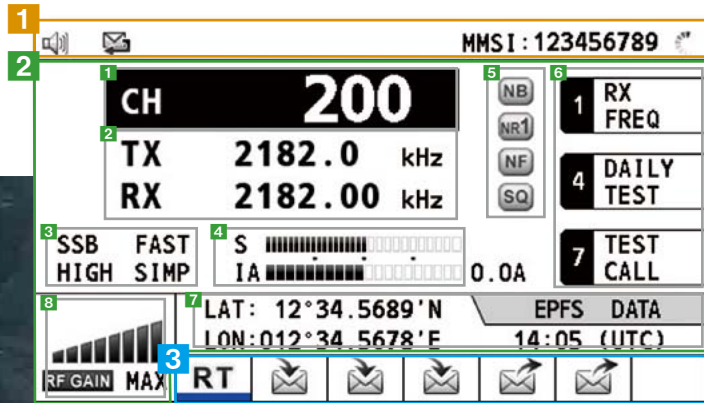

### DSC SCAN display

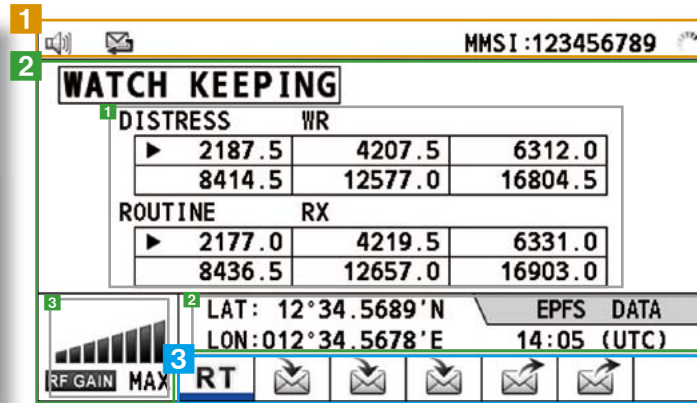

### DSC display

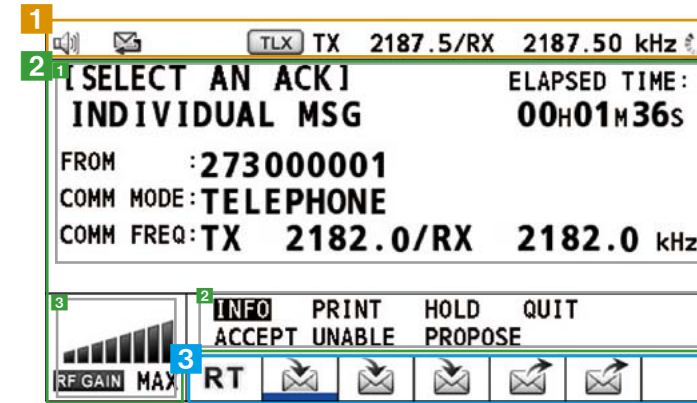

### Menu display

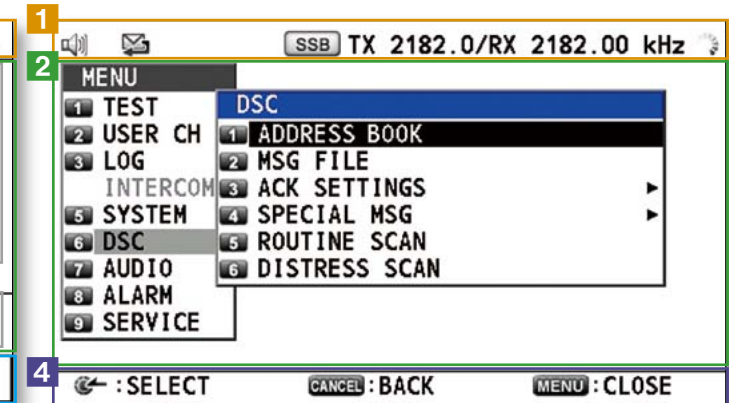

#### 1 Status segment

Indicating the status of equipment, i.e., speaker ON/OFF, unread DSC message in the inbox, hardware error, etc. Also, MMSI is shown in radiotelephone and DSC scan displays.

#### 2 Information segment

- Displaying:
- 1 user channel selected
  - 2 operating frequencies
  - 3 class of emission, AGC, output power and communication mode
  - 4 signal strength, meter reading (IC, VC, RF, VS and IA (antenna current))
  - 5 currently activated functions, i.e., noise blanker, etc.
  - 6 short-cut functions assigned for 1, 4 and 7 on the numeric keypad
  - 7 own ship L/L, Time
  - 8 indications of RF input attenuator ON/OFF as well as RF gain

#### 2 Information segment

- Displaying:
- 1 DSC watch frequencies (both distress and routine)
  - 2 own ship L/L, Time
  - 3 indications of RF input attenuator ON/OFF as well as RF gain

#### 1 Status segment

Indicating status of equipment, i.e., speaker ON/OFF, unread DSC message in the inbox, hardware error, etc., TX/RX frequencies/class of emission for successive communication.

#### 2 Information segment

- Displaying:
- 1 DSC contents, status and information
  - 2 a list of available operator actions
  - 3 indications of RF input attenuator ON/OFF as well as RF gain

#### 2 Information segment

Displaying menu tree

#### 3 Tab segment

Up to 7 active procedures can be displayed in this segment. The procedures are for operating: radiotelephone, distress alert transmission, distress alert reception, general DSC message transmission and general DSC message reception.

#### 4 Guide segment

Guide to short-cut key functions is displayed.

### Quick-access functions



On the menu setting, three quick-access functions can be assigned for 1, 4 and 7 on the numeric keypad, and those assigned functions are displayed on the Radiotelephone display. The list of functions assigned for quick-access includes: TX frequency setting, RX frequency setting, class of emission setting, AGC setting, output power setting, TX frequency monitoring, showing the list of test messages, showing the list of message files, excusion of daily test, showing the list of log files, and intercom functions.

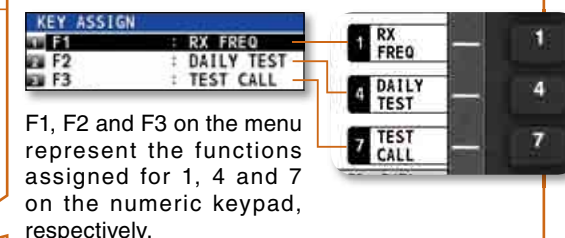
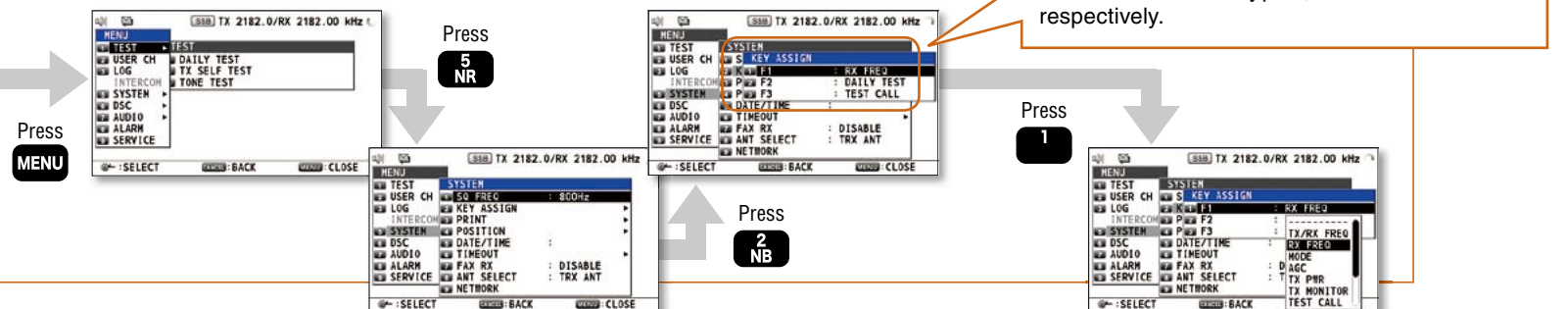

F1, F2 and F3 on the menu represent the functions assigned for 1, 4 and 7 on the numeric keypad, respectively.

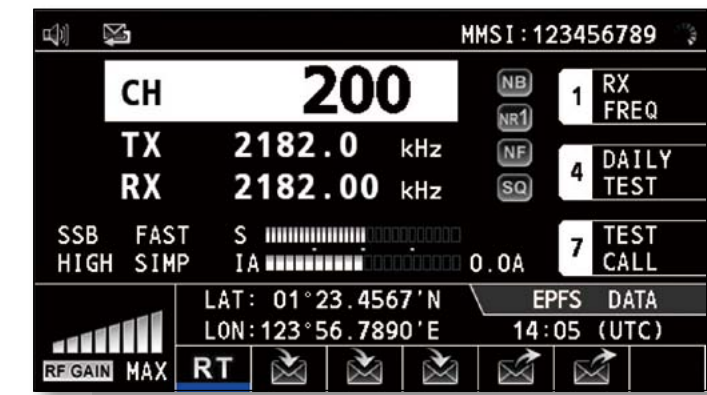

**Night Mode**  
Night mode is selectable for wheelhouse operation.